

EIGHT Series XL precision air carts - more capacity, more features



8630 EIGHT Series XL with quad steer.



- Tank sizes: 8,730 L (240 bu.) to 15,239 L (630 bu.)
Tow between & tow behind configurations
- Overall width: 3.78 m
- Overall height: 4.6 m



EIGHT Series XL complete with liquid tank option.

More capacity, user friendly features, precise metering and proven distribution - whether you are changing product or setting rates, the clean basic design and operation of the EIGHT Series XL Air Cart lets you simply and easily get on with the task at hand.

As your cropping practices change, the EIGHT Series XL adapts right along with you. Stackable collectors allow quick and easy change over from single to double shoot. Simply slide a rod to divert product from one air stream into another.



Patented flat fan divider heads maintain the smooth horizontal flow of product as it leaves the primary runs to divide into the secondary runs. The abrupt directional change common to vertical divider heads is eliminated. Outlets on the Flat Fan Divider are matched with metering wheel width for superior overall metering accuracy.



All models are equipped with a 25.4 cm (10") auger for a fast fill.



The walk-through tank design creates a firm standing platform with fill lids at waist level.



Spiral fluted metering wheels gently roll product into the air stream, accurately metering fine to coarse seed and fertilizer.

7000 Series air carts - field proven, easy to use



2-3 Meter Controlled Traffic Air Carts

- Tank sizes: 6,550 L (180 bu) to 10,910 L (300 bu).
- Tow between & tow behind configurations.
- Loading auger: 17.8 cm (7") on 7180 models
20.3 cm (8") on 7240 & 7300 models.



Spiral fluted metering wheels move the product smoothly into the air stream.



The Post-Drive Transmission uses a positive lock on all drive sprockets to deliver smooth and reliable metering. The positive ground drive from the Air Cart wheel ensures precise product rates at all times.



The high efficiency air system design and 13" diameter fan provide a low horsepower draw from the tractor hydraulics.

- 7000 Air Carts feature walk through tank design.
- Very accurate seed & fertilizer calibration.
- Single, double shoot capability.
- High efficiency fan.

Morris Concept 2000 Specifications and Options

Base Model	Ext'd Model	Working Width			Number of Shanks			Transport			Weight		
		12"	10"	9"	12"	10"	9"	Width			with 755 LH Trip		
		30.5 cm	25.4 cm	22.9 cm	30.5 cm	25.4 cm	22.9 cm	12"	10"	9"	12"	10"	9"

3 Section: Regular Transport													
23' 7 m	23' 7.01 m	24' 7.31 m	23.5' 7.16 m	23	29	31	17' 7"	11'	11' 7"	11' 1"	11,575 lb	12,665 lb	12,305 lb
							5.36 m	3.35 m	3.53 m	3.38 m	5,261 kg	5,757 kg	5,593 kg
25'	25'	26'	25'	25	31	33	17' 7"	12'	12' 5"	11' 10"	12,045 lb	13,190 lb	12,775 lb
							5.36 m	3.66 m	3.78 m	3.61 m	5,475 kg	5,995 kg	5,807 kg
29' 8.8 m	29'	31'	29.5'	29	37	39	17' 6"	14'	14' 8"	14'	13,180 lb	13,945 lb	14,110 lb
							5.33 m	4.27 m	4.47 m	4.27 m	5,991 kg	6,339 kg	6,414 kg
31'	31'	32.5'	31'	31	39	41	17' 6"	14' 10"	15' 6"	14' 10"	13,650 lb	14,470 lb	14,580 lb
							5.33 m	4.52 m	4.72 m	4.52 m	6,205 kg	6,577 kg	6,627 kg
33'	33'	34'	32.5'	33	41	43	17' 6"	15' 10"	16' 4"	15' 7"	14,230 lb	15,095 lb	15,155 lb
							5.33 m	4.83 m	4.98 m	4.75 m	6,468 kg	6,861 kg	6,889 kg

3 Section: Wide Transport													
32' 9.75 m	32'	34'	32.5'	32	41	43	20' 6"	14'	14' 8"	14'	14,060 lb	14,910 lb	15,030 lb
							6.25 m	4.27 m	4.47 m	4.27 m	6,391 kg	6,777 kg	6,832 kg
34'	34'	36'	34'	34	43	45	20' 6"	14' 10"	15' 6"	14' 10"	14,530 lb	15,435 lb	15,500 lb
							6.25 m	4.52 m	4.72 m	4.52 m	6,605 kg	7,016 kg	7,045 kg
36'	36'	37.5'	35.5'	36	45	47	20' 6"	15' 10"	16' 4"	15' 7"	15,110 lb	16,060 lb	16,075 lb
							6.25 m	4.83 m	4.98 m	4.75 m	6,868 kg	7,300 kg	7,307 kg
38'	38'	41'	38.5'	38	49	51	20' 2"	17'	18' 1"	17'	15,190 lb	16,185 lb	16,335 lb
							6.15 m	5.18 m	5.51 m	5.18 m	6,905 kg	7,357 kg	7,425 kg
40'	40'	42.5'	40'	40	51	53	20' 2"	17' 8"	18' 11"	17' 8"	15,660 lb	16,710 lb	16,805 lb
							6.15 m	5.38 m	5.77 m	5.38 m	7,118 kg	7,595 kg	7,639 kg
42'	42'	44'	41.5'	42	53	55	20' 2"	18' 8"	19' 9"	18' 5"	16,240 lb	17,335 lb	17,380 lb
							6.15 m	5.69 m	6.02 m	5.61 m	7,382 kg	7,880 kg	7,900 kg

5 Section													
50' 15.24 m	50'	54'	50.5'	50	65	67	23' 3"	18' 8"	19' 5"	18' 5"	22,855 lb	24,365 lb	24,435 lb
							7.09 m	5.69 m	5.92 m	5.61 m	10,389 kg	11,084 kg	11,107 kg
52'	52'	56'	52'	52	67	69	23' 3"	18' 8"	19' 5"	18' 5"	23,325 lb	24,910 lb	24,905 lb
							7.09 m	5.69 m	5.92 m	5.61 m	10,602 kg	11,323 kg	11,320 kg
56'	56'	61'	56.5'	56	73	75	24' 3"	18' 8"	19' 5"	18' 5"	23,425 lb	25,180 lb	25,150 lb
							7.39 m	5.69 m	5.92 m	5.61 m	10,648 kg	11,445 kg	11,432 kg
58'	58'	62.5'	58'	58	75	77	24' 3"	18' 8"	19' 5"	18' 5"	23,895 lb	25,705 lb	25,620 lb
							7.39 m	5.69 m	5.92 m	5.61 m	10,861 kg	11,684 kg	11,645 kg
60'	60'	64'	59.5'	60	77	79	24' 3"	18' 8"	19' 5"	18' 5"	24,475 lb	26,330 lb	26,195 lb
							7.39 m	5.69 m	5.92 m	5.61 m	11,125 kg	11,968 kg	11,907 kg

Trip Mechanism	400 Spring Cushion	1" (2.54 cm) x 2" (5.1 cm) Shank with 1-3/4" (4.4 cm) Centres fits 47 Degree tillage tools. 27" (68.6 cm) Sweep to Frame Clearance. Trip Force 400 lb (180 kg). Available on 9" (22.9 cm) and 10" (25.4 cm) spacing.
	550 Spring Cushion	1" (2.54 cm) x 2" (5.1 cm) Shank with 1-3/4" (4.4 cm) Centres fits 47 Degree tillage tools. 27" (68.6 cm) Sweep to Frame Clearance. Trip Force 550 lb (248 kg). Available on 9" (22.9 cm), 10" (25.4 cm) and 12" (30.5 cm) spacing.
	755 LH Automatic Trip	1-1/4" (3.18 cm) x 2" (5.1 cm) Shank with 2-1/4" (5.72 cm) Centres fits 50 Degree tillage tools. 30" (76.2 cm) sweep to Frame Clearance. Trip Force 750 lb (340 kg). Available on 9" (22.9 cm), 10" (25.4 cm) and 12" (30.5 cm) spacing.
	Hydraulic Trip	1-1/4" (3.18 cm) x 2" (5.1 cm) Shank with 2-1/4" (5.72 cm) Centres fits 50 Degree tillage tools. 30" (76.2 cm) sweep to Frame Clearance. Trip Force adjustable 150 - 700 lbs (68 kg - 318 kg). Available on 9" (22.9 cm), 10" (25.4 cm) and 12" (30.5 cm) spacing.
Overall Length	26' (7.93 m) on all Models	
Frame Depth	102" (2.59 m) on all Models	
Rows	4 Rows on all Models	
Standard	Safety Lights, Safety Chain	
Options	Mud Scrapers, Mounted Packers, and Mounted Harrows	

FRAME CONFIGURATIONS										
Base Model	Ext'd Model	Main Frame		Inner Wings		Outer Wings		Extensions		Tires
		12'	15'	6'	9'	12'	6'	9'	2	
23										I
25										I
29										II
31										II
33										II
32										II
34										II
36										II
38										II
40										II
42										II
50										III
52										III
56										III
58										III
60										III

TIRE CONFIGURATIONS - OPTIONAL	
Tire - I	Main Frame (4) 9.5L x 15FI Load Range D
	Wing Frame (2 per frame) 9.5L x 15FI Load Range D
Tire - II	Main Gauge Wheel (2) 9.5L x 15FI Load Range D
	Wing Gauge Wheel (1 per frame) 9.5L x 15FI Load Range D
Tire - III	Main Frame (4) 11L x 15FI Load Range D
	Wing Frame (2 per frame) 9.5L x 15FI Load Range D
Tire - IV	Main Gauge Wheel (2) 11L x 15FI Load Range D
	Wing Gauge Wheel (1 per frame) 11L x 15FI Load Range D
Tire - V	Main Frame (4) 11L x 15FI Load Range F
	Wing Frame (2 per frame) 9.5L x 15FI Load Range D
Tire - VI	Main Gauge Wheel (2) 11L x 15FI Load Range F
	Wing Gauge Wheel (1 per frame) 11L x 15FI Load Range D

PRINTED IN CANADA 1010.500



CORPORATE OFFICE & TRAINING CENTRE - 2131 Airport Drive, Saskatoon, SK Canada S7L 7E1
Telephone: 306.933.8585 Fax: 306.933.8626
www.morris-industries.com Questions? email: info@morris-industries.com

The policy of MORRIS INDUSTRIES LTD. is one of continuing improvement; therefore, the company reserves the right to change specifications without notice.



Concept 2000

Air Seeding & Tillage System



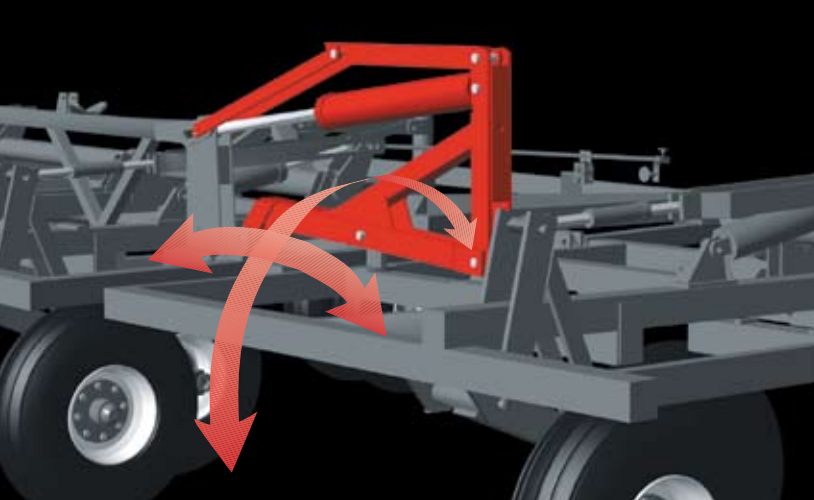

Flexibility and contourability is a trademark of Morris' floating frame design featuring independent wing sections. Floating frame sections, with a tricycle suspension and patented frame coupling assures flexibility while easing the stress on the frame member joints. This allows the frames to adjust to and follow the contours of the land. (Because of the unique floating frame design Morris does not recommend the use of mechanical end markers).

The tricycle suspension is created through three support points on each frame. A dual castor centered between the walking beam axles give the tricycle suspension for the mainframe. Similarly, the centered gauge wheel, walking beam axle and ball joint pivots maintain the three point support on the wing frames.

Independent hitch trusses are used to pull the frames. Stress induced by the trips is evenly distributed across the hitching, greatly extending the service life of the machine.



Universal Ball Joint

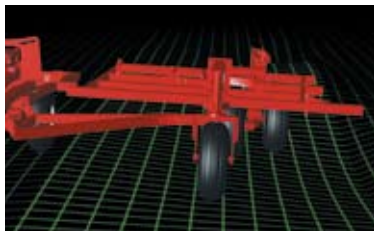

Floating frame design features independent wing sections.



The Concept 2000 dual purpose system proves invaluable to farming operations worldwide. Whether you require a heavy duty chisel plow to till soil, cut through residue, and leave an exceptional field finish or the accuracy of a precision air seeding system, the Concept 2000 offers the best of both worlds.



A standard feature of the Concept 2000 is the hydraulic and mechanical depth control system for seeding and tillage operations.

This feature makes it easy to set machine depth with a convenient single point adjustment. The Hydraulic depth stop valves ensure consistent working depth by isolating the implement's hydraulics from the tractor in tillage operations. It is recommended that the mechanical depth stops are used when seeding.

The Concept 2000's parallel lift depth control system keeps the machine level from front to back, providing superior contouring for consistent seed depth. The system provides excellent ground transport.

A unique lifting linkage raises the front tire on the wing walking axles when turning on headlands.



Lifting linkage prevents gouging and ridging for a smoother field finish.



The Concept 2000 keeps you at work in the most demanding trash conditions. The four row Z trip pattern allows trash to flow freely through the machine. To improve trash clearance capabilities, the spacing between ranks increases from 68.6 cm (27") between the first and second rows to 78.7 cm (31") between the second and third, and to 101.6 cm (40") between the third and fourth. In combination with the short contour length of the machine and the extra high ground clearance provided by the trip assembly, the increase in distance between ranks from front to back provides superior performance in heavy trash conditions.

The Concept 2000 features three trip assembly options - the 755LH 340 kg (750 lb) trip, 250 kg (550 lb) and the 186 kg (400 lb) trip. All Morris trips accept a variety of Morris seed and fertilizer boots, as well as other standard sweeps and spikes.

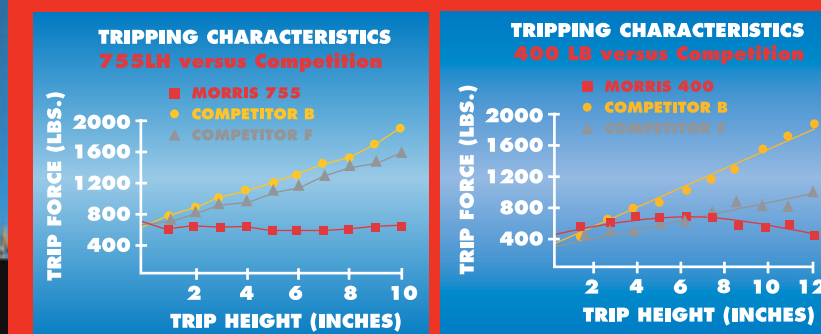

The unique tripping characteristic reduces stress on the trip components and frame members.



The new Morris 250 kg (550 lb) trip features a 2.54 cm (1") shank for extra durability.

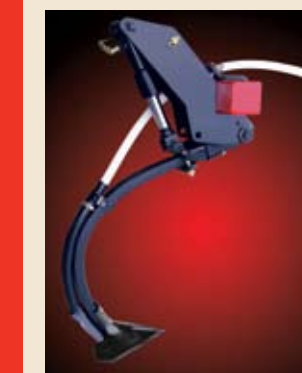
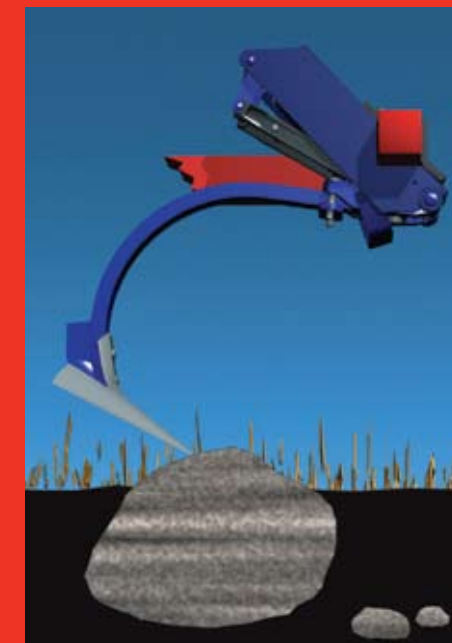

Hydraulic tyne option – Trip out pressure can be increased or decreased on the go.

Adjustable trip out force – during hard pulling, trip out can be set higher to avoid unnecessary tripping. In rocky or obstacle laden fields, trip out force can be reduced in order to clear large solid obstacles.

Higher durability – recoil is much softer with the hydraulic trip.

Hydraulic pressure control – to clear obstacles in the field, the farmer can operate the tractor remote to decrease the system pressure, and then increase the pressure back to the pre-set operating pressure once the obstacles have been cleared. A ball valve can be used to isolate the accumulator circuit once the pressure has been set. In this configuration trip out force remains set at one point, and can not be changed from the tractor.

The new Hydraulic tyne can be locked up for both storage & and spacing. For example, lock out every second tyne for summer cropping practices (allows farmers with 38 cm (15") spacing to summer crop on 76 cm (30") spacing).

Precision seeding system doubles as heavy duty chisel plow

Dual Purpose Concept 2000 Seeding & Tillage System

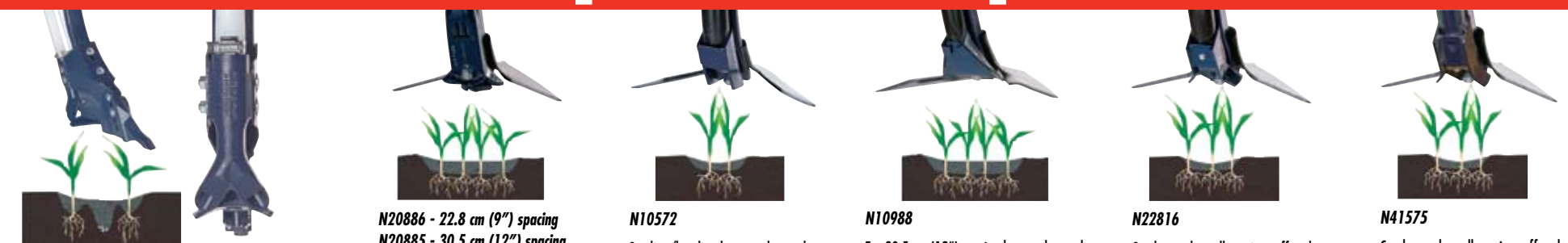

Paired Row S25962 "C" Shank
Paired Row Dual Shoot Opener fits shanks with a 4.4 cm (1 3/4") or 5.7 cm (2 1/4") hole spacing. Replaceable chrome tip, with an optional carbide point is adjustable for wear and fertilizer placement. The fertilizer depth is adjustable to 2, 3.8, or 5.7 cm (3/4", 1 1/2", 2 1/4") below the seed rows ensuring separation. Seed is placed in two rows 7.6 cm (3") apart. Seed spread is approximately 2.5 cm (1"). Use in all soil conditions and with 8.9 cm (3 1/2") mounted packer wheels.

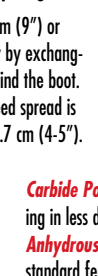

Carbide Point Option The Carbide Point is designed to enhance the Morris Gumbo Boot Kits (S25962). The Carbide Point's durability will increase the number of acres between point replacement, resulting in less down time and increased productivity during the critical seeding season. Less wear also ensures consistency of depth control.

Anhydrous Option The application of anhydrous or liquid fertilizer is available with Morris double shoot openers. On conventional "C" shank openers the 1.27 cm (1/2") poly tube inserts down the standard fertilizer tube providing a positive seal. Safe levels of actual nitrogen will vary with soil conditions at the time of application. Consult your local agronomist for recommended levels in your area.



Universal Arm with quick detach pin for changing packers and harrows.



A mounted harrow option provides extra soil levelling for a smoother field finish.



A Mounted packer option for on-row packing ensures excellent seed to soil contact.

The Concept has one of the shortest contour lengths in the industry - only 2.4 m (96") and a true floating hitch to maintain consistent seeding or tilling depth over sharp knolls, hills and draws.

The walking beam axles, placed near the rear of the frame, add another advantage. Even in the most challenging conditions, the machine follows the terrain maintaining uniform depth across the entire machine. Optional mud scrapers are available for the inner tires to aid in wetter conditions.



Single point safety latch.

A 30.5 cm (12") sweep to ground clearance in transport makes it easier to travel over high crowned roads. This clearance also provides access when changing openers.

Weight is transferred to the front of the machine in transport position. This provides greater stability, even with the mounted packer or harrow option.

Note: For optimum placement and minimum soil disturbance, seeding speed should not exceed 5 m.p.h. Soil moisture levels and soil types may affect opener operation.